

Article number: 3901250050700

Description: Worm gear with solid input shaft
VF 250P-50-HS

Measures

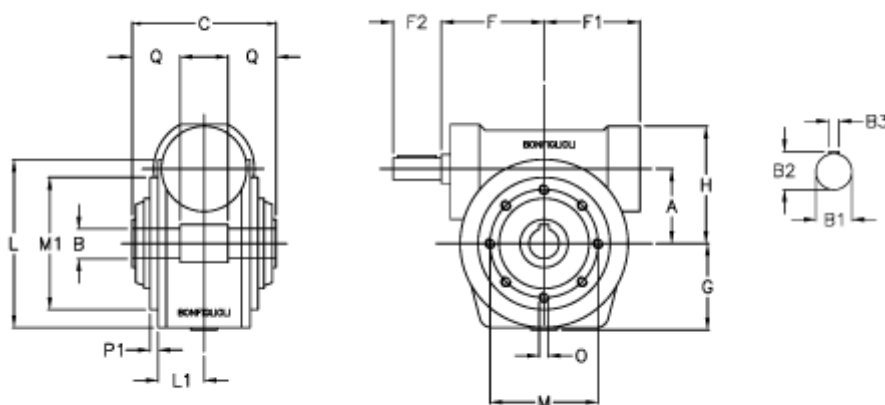

a	= 250.0	F1 = 318	O = M16x40
B	= 110	F2 = 110	P1 = 5.0
B1	= 55	g = 265	Q = 85.0
B2	= 59.0	H = 370	
B3	= 16	L = 450.0	
C	= 320	L1 = 310.0	
Description	= VF 250P-xx-HS	m = 400	
F	= 276.0	M1 = 350	